

# AP 5001 SAFETRACK™

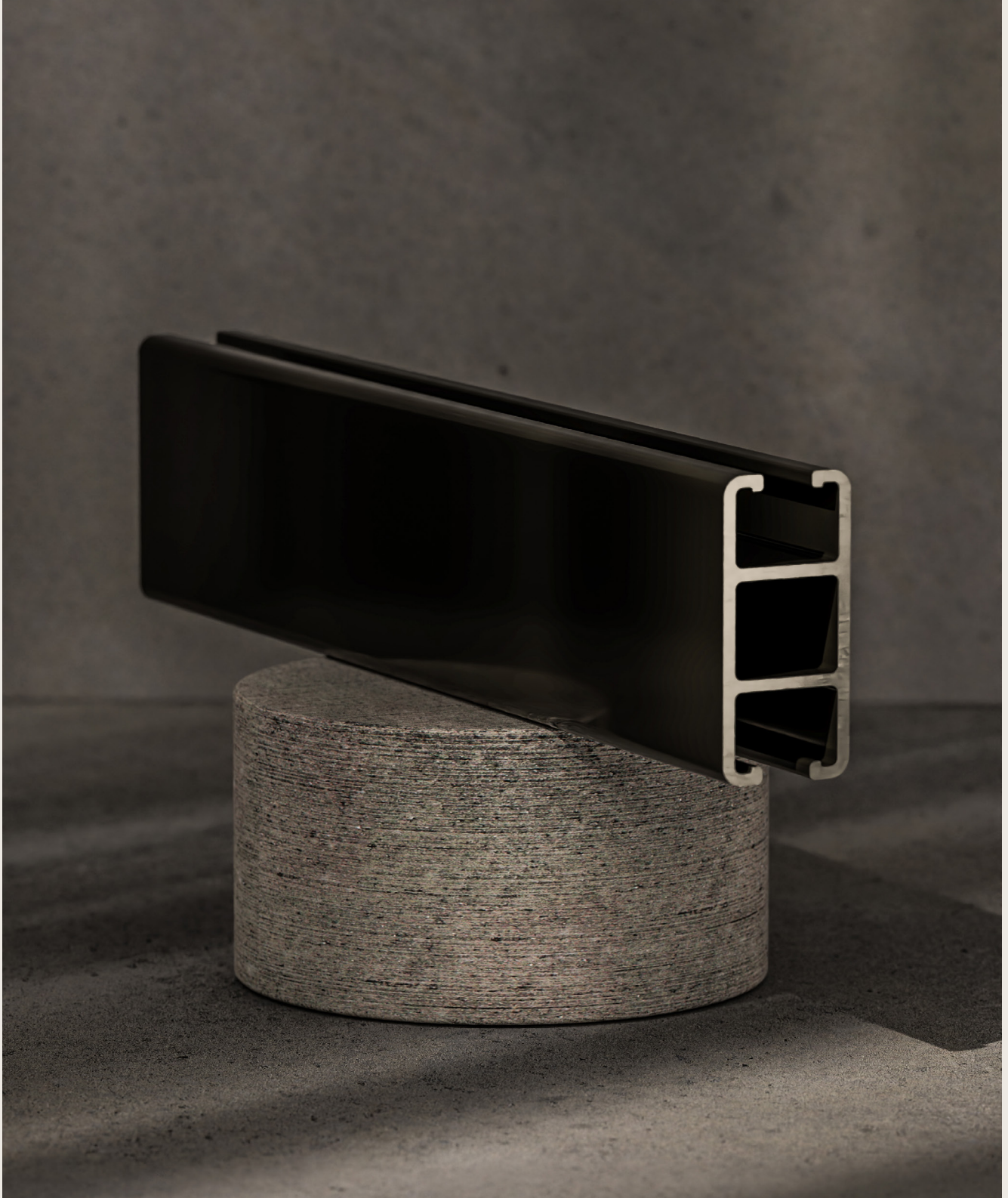



The AP 5001 cubicle track works together with AP Safetrack™, our range of anti-ligature accessories, developed for installation in psychiatric hospitals. To avoid self-harm or loss of life, the AP Safetrack is designed to release from attachment points such as wall brackets and ceiling supports at a pull of as little as 8 kg. Safetrack is tested and certified by the Danish Technological Institute and meets the international anti-ligature standards.

### COLOURS



White



Super Silver



Black

Powder coating and wet lacquering in all RAL and standard NCS colours is possible for an additional charge.

### ORIGIN & MATERIALS



Extrusion  
Sweden



Lacquering  
Denmark



Processing  
Denmark

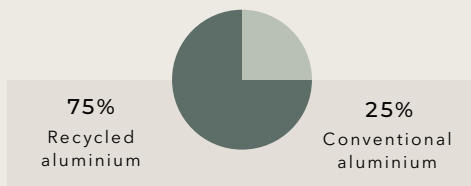

OR



Extrusion  
Poland



Lacquering  
Poland



Processing  
Denmark



We offer our AP 5001 in two versions. A conventional version extruded from virgin material or a recycled SUSTAIN™ version ("S") extruded from min. 75% recycled post-consumer aluminium. Please inquire about available combinations.

1:1 drawing

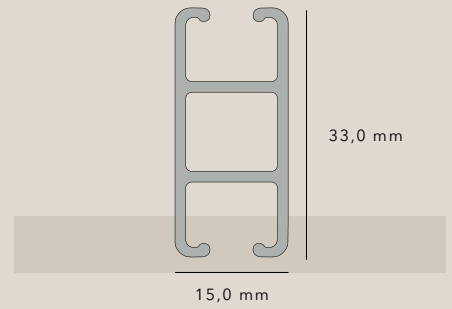

### RECOMMENDED USE



Ceiling-mounting



Wall mounting



Ceiling supports



Bending



Milling



Recessing

### SPECIFICATIONS

#### Materials:

Aluminium alloy 6060/T6 or  
Hydro CIRCAL® 75 R

#### Operation:

Hand drawn

#### Ext. dimensions:

15,0 mm x 33,0 mm

#### Track width:

6,0 mm

#### Length:

6000 mm

#### Max. load:

Up to 8 kg (see sep. table)

#### Bending radius:

Min. 10 (recommended)

### MAXIMUM LOAD

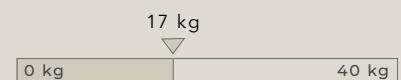

The recommended max. load depends on many factors. Please see our Max. Load table.

PROFILE

	DESCRIPTION	COLOUR
	<p><b>AP 5001S / AP 5001</b></p> <p>Wide track profile 15 mm x 33 mm</p> <p>In lengths of 6 metres &amp; bulks of 60 or 180 metres</p> <p><i>Cubicle track with anti-ligature accessories developed for technical solutions in health care facilities</i></p>	<p>White Silver Black</p>



END CAPS

5041	5040		
			
<p>End cap</p>	<p>End cap</p>		
<p>White Grey Black</p> <p>Quantity: 100 pcs</p>	<p>White Silver Black</p> <p>Quantity: 50 pcs</p>		

BRACKETS

5010ST	5017ST		
			
<p>Safetrack™ ceiling bracket</p>	<p>Safetrack™ end bracket for wall mounting</p>		
<p>White Silver Black</p> <p>Quantity: 10 pcs</p>	<p>White Silver Black</p> <p>Quantity: 10 pcs</p>		

## SAFETRACK GLIDERS

5738ST GREY	5738ST RED		
			
Safetrack™ special glider Releases by a pull of 8 kilos <i>Approved for use with profile 5001</i>	Safetrack™ special glider Releases by a pull of 12 kilos <i>Approved for use with profile 5001</i>		
Grey  Quantity: 200 pcs	Red  Quantity: 100 pcs		

## ADDITIONAL ACCESSORIES

F4045ST	5020	N32ST	
			
Safetrack™ bottom part for 16 mm tube	V ceiling support 8 mm tube	Safetrack™ bracket for V ceiling support with 8 mm tube	
White Silver Black  Quantity: 10 pcs	White Silver  Quantity: 1 pc	White Silver Black  Quantity: 100 pcs	

### Instructions for using the SAFETRACK™ gliders

*Place two (2) pcs. 5738ST RED as the first gliders in the track and one (1) as the last glider; if possible on the outside of the stopper.*

*Place the 5738ST GRAY gliders between these two positions.*

*Use a maximum of 10 gliders per metre track.*

